

FLUE GAS ANALYSER

GA-12 *PLUS*

Operating manual

03/ 2013

V 0.99

madur
E L E C T R O N I C S

Index

| | |
|---|-----------|
| 1. Description of GA-12plus analyser | 3 |
| 2. Maintenance | 4 |
| 2.1. Electrochemical cells | 4 |
| 2.2. Gas channel | 4 |
| 2.3. Battery | 4 |
| 2.4. Service | 5 |
| 2.5. Errors | 5 |
| 2.6. Switching off after use | 5 |
| 3. Operation | 6 |
| 3.1. Use of the keyboard | 6 |
| 3.1.1. Description of the keys | 7 |
| 3.1.2. Editing numbers | 7 |
| 3.2. Basic operation | 8 |
| 3.2.1. Getting started | 8 |
| 3.2.2. Switching on | 8 |
| 3.3. Results screens | 9 |
| 3.3.1. The info bar | 9 |
| 3.3.2. The menu bar | 9 |
| 3.3.3. Results | 10 |
| 4. Menu | 11 |
| 4.1. Storing results | 11 |
| 4.2. Action menu | 14 |
| 4.3. Chart | 19 |
| 4.4. Measurement parameters | 21 |
| 4.5. Main menu | 23 |
| 4.5.1. Settings | 23 |
| 4.5.2. Burner regulation | 24 |
| 4.5.3. Reports | 25 |
| 4.5.4. Clock | 27 |
| 4.5.5. Service | 27 |
| 4.5.5.1. Info | 28 |
| 4.5.5.2. Control list | 28 |
| 4.5.5.3. Calibration with gases | 29 |
| 4.5.5.4. Pressure calibration | 30 |
| 4.6. Printing | 32 |
| 5. Flow velocity measurement | 33 |

1. Description of GA-12^{plus} analyser

GA-12plus is a mobile boiler gas analyser extending the series of our well-known GA-12 analysers. There can be up to four gas sensors installed in the device. The basic version of the device is adjusted to measure the concentration of following gases: O₂, CO, NO. Optionally NO₂, SO₂ or H₂S sensor can be installed as the last, fourth sensor.

To guarantee the accuracy of measurement the velocity of the gas flow through the analyser is stabilised. The efficient pump additionally makes it possible to measure the content of soot in the flue gases.

The analyser can be equipped with either one or two pressure sensors. In the first case it is unavoidable to switch the pump off in order to measure the pressure. In the second case the measurement of the pressure can be done simultaneously to gas measurements and does not interrupt them.

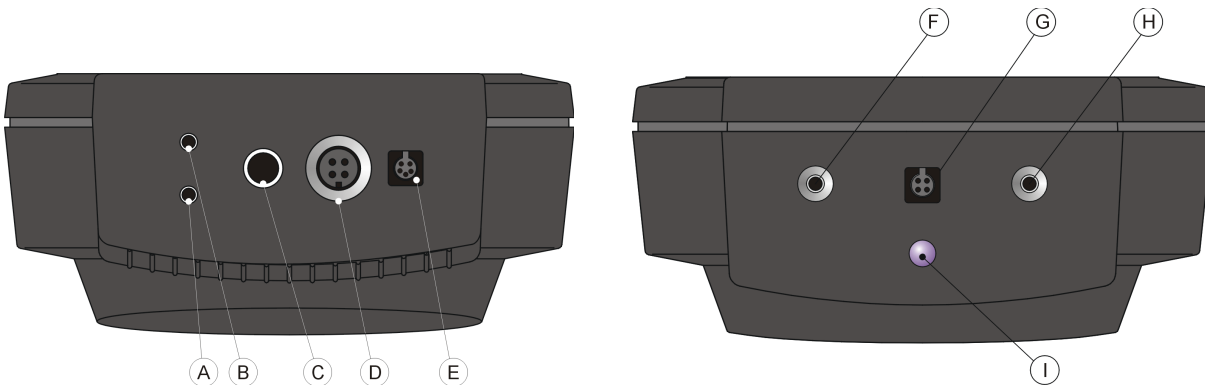

GA-12^{plus} analyser – bottom view:

- A – basic pressure sensor inlet (+)
- B – gas inlet
- C – gas outlet
- D – gas probe socket
- E – HT (humidity + temperature) probe socket

GA-12^{plus} analyser – top view

- F – differential pressure sensor inlet (-) – only in the version with two pressure sensors
- G –RS-232C interface socket
- H – differential pressure sensor inlet (+) – only in the version with two pressure sensors
- J – IR emitter for communication with printer

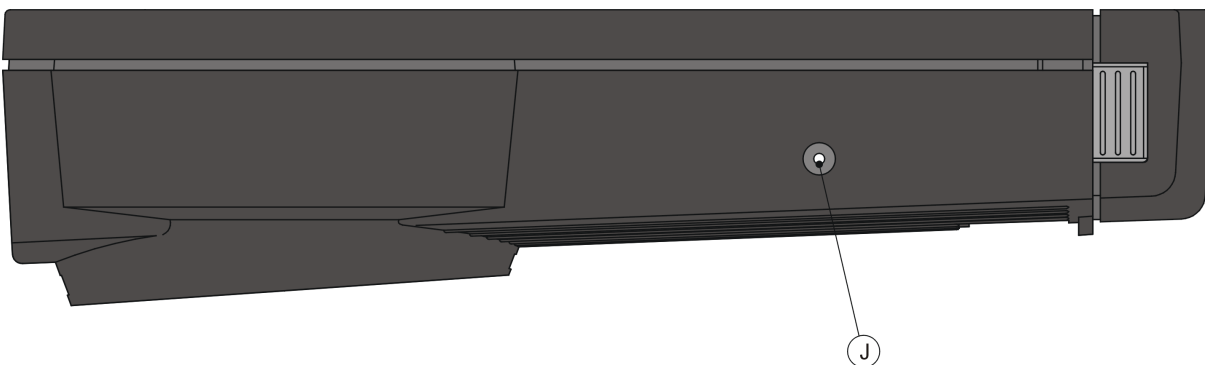

GA-12^{plus} analyser – side view

- J – mains adapter socket

2. Maintenance

2.1. *Electrochemical cells*

To extend the lifetime of the cells and guarantee the accuracy of the measurements the points listed below should be followed.

- The cells should not be exposed to influence of the concentration exceeding the measurement range.
- All the cells can react unpredictably to chemicals whose components are not typically found in flue gases. For this reason the equipment should not be cleaned with chemical solvents. The vapour produced by such solvents can lead to destabilisation and even permanent damage to the cells should it penetrate into the gas chamber.
- The cells have a voltage applied to them even when the analyser is switched off. It is therefore advised to make sure that there are always charged batteries in the analyser.
- It is advised not to switch the analyser off before the gas system is free of flue gases.
- The analyser which is not to be used for some time should be kept in a cool place. This will reduce the wear on the cells.

2.2. *Gas channel*

An in-line filter with the condensate separator protects the gas channel of the analyser from condensed water contained in fumes. The filter element will become dirty with use and should be changed when necessary. The water that condenses in the condensate separator should be emptied as required.

2.3. *Battery*

The device uses Li-Ion 3,6V battery.

Warning:

If the instrument is not in use for some time, then the battery will nevertheless be consumed since certain circuits are permanently in use. For this reason the state of charge of the batteries should be checked monthly at least.

2.4. Service

Due to the fact that electrochemical cells' parameters change with time it is necessary to carry out a periodical service connected with either the calibration of the electrochemical cells or their replacement. We recommend that service be carried out every 12 months or after the device have worked for 200 hours.

2.5. Errors

The instrument has a self-check function. When an error occur it would be shown on the screen [Control list](#).

2.6. Switching off after use

The lifetime of the electrochemical cells depends on the use of the instrument. Wear on the cell is greater at higher gas concentrations and during longer measurements. This leads to a slow deterioration of the cell.

Warning:

For this reason the instrument should not be switched off until all the flue gases have been purged from the system with clean air and the instrument has been allowed to run in air for a few minutes.









3. Operation

3.1. Use of the keyboard







The analyser's appearance

3.1.1. Description of the keys

-  - Left function key. Carries out the function shown on the display whilst the instrument is switched on.
-  - Right function key. Carries out the function shown on the display whilst the instrument is switched on.
-  - Centre function key. Switches the instrument on. Carries out the function shown on the display when the instrument is switched on.
-  - Calls the printing options.
-  - Switches the instrument off.
-  - On a results screen calls the **Chart** menu, in text mode shifts the cursor to the left
-  - On a results screen calls the option **Menu**, in text mode shifts the cursor to the right.
-  - Moves the cursor upwards in a menu. In text mode increases the value. On a results screen chooses the next screen.
-  - Moves the cursor downwards in a menu. In text mode decreases the value. On a results screen chooses the next screen.

3.1.2. Editing numbers

Numbers are entered as follows:

-  and  - move the cursor backwards or forwards to the digit to be changed.
-  and  - increases/decreases the value of the marked digit.

3.2. Basic operation

3.2.1. Getting started

Connect the individual parts of the instrument:

- connect the gas probe.
- ensure that the gas outlet is not blocked.

3.2.2. Switching on

The instrument performs a zero calibration immediately after being switched on.

Warning:

During zero calibration the probe must be outside the flue gas channel.



After the zero calibration has been completed the [Options](#) open automatically. Here the measuring parameters can be checked or changed. See also point [Measurement parameters](#).

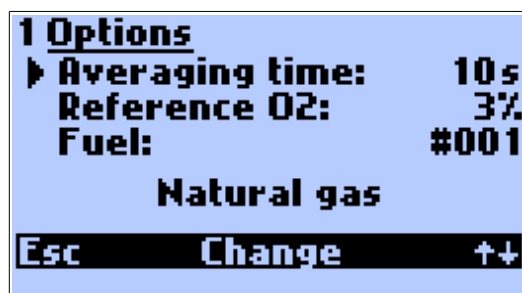

3.3. Results screens

The function keys **Data** or **Esc** will automatically call up the results screen from any point. Below there are two examples of results screens.

3.3.1. The info bar

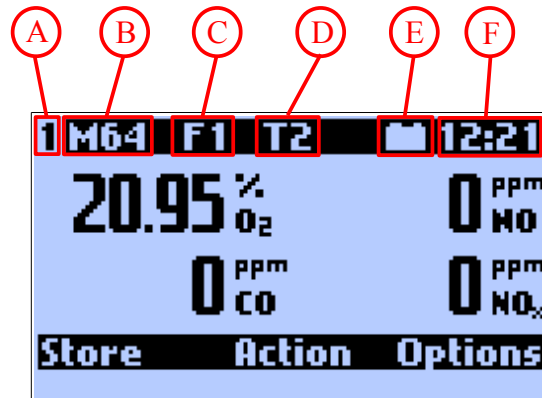

- A) The number **1** stands for the first results screen. Four results screens can be defined. These can be called up using the up and down keys.
- B) **M64** shows how many memory spaces are still available.
- C) **F1** shows the chosen fuel. The instrument contains 6 fixed and 4 programmable fuels. These are numbered 0...9.
- D) **T2** shows the set averaging time. This can be programmed in fixed steps between 2 and 180 seconds. If the period of time measured since the starting of the instrument is shorter than the chosen averaging time, this field will refer to the current averaging time.
- E) **Plug/Battery** - The symbol of the plug means that the instrument is being supplied with the energy from the outside, the symbol flashes until the charging of the battery is completed; battery stands for the inner battery of the instrument and also shows the state of charge of the battery.
- F) **12:21** shows the current time as set in the analyser.

3.3.2. The menu bar

The menu bar at the base of the display shows the use of the function keys. The possibilities are explained under the point [Menu](#).

3.3.3. Results

All the results of measurements and calculations are shown as averaged values. Averaging time is chosen by the user under [Options](#) from 2 – 6 – 10 – 20 – 30 – 60 – 120 – 180 seconds.







The user can define the content of the individual results screens. The necessary software, madurPortable, is to be found on the utility disk.

Here is a list of all measured or calculated variables that can be shown on the results screens:

- Volumetric concentration of the gases: O₂, CO, NO, NO_x, CO₂, SO₂, NO₂ and H₂S (depending on the analyser's configuration)
- Undiluted volumetric concentration of the gases CO_u, NO_{xu}, NO_u, NO_{2u}, SO₂ and H₂S_u
- Mass concentration of the gases:
 - absolute: CO_m, NO_{xm}, NO_m, SO_{2m}, NO_{2m} and H₂S_m
 - relative, related to a defined level of rest oxygen: CO_{rel}, NO_{xrel}, NO_{rel}, SO_{2rel}, NO_{2rel} and H₂S_{rel}
- Emission of the gases related to the energy value: ECO, ENO_x, ESO₂, ENO₂, ESO₂, EH₂s
- Combustion parameters: qA, Sco, ETA, ETA*, Lambda, TI, EA
- Temperatures of the combustion gas, the air and inside of the analyser.
- Draught/differential pressure and flow rate
- Relative humidity of the gas in the analyser.
- Dewpoint
- Battery voltage

4. MENU

From the results screens the following options can be activated with the keyboard:

- **Store** –  Left function key.
- **Action** –  Centre function key.
- **Options** –  Right function key.
- **Chart** –  Arrow left.
- **Menu** –  Arrow right.
- **Print** –  Key with a printer shown on it.
- **Switch off** –  Pressing the round, red key will switch the instrument off completely.

4.1. Storing results

The **Store** option can be reached from any results screen by pressing the left function key . The results on the screen are stored in a buffer and remain there until stored permanently.

The results are stored in the form of reports.

If the report should also include the chimney draught, or the soot content then this measurement must be carried out before storing the results.

Results can be stored in three different ways:

Averaged results:

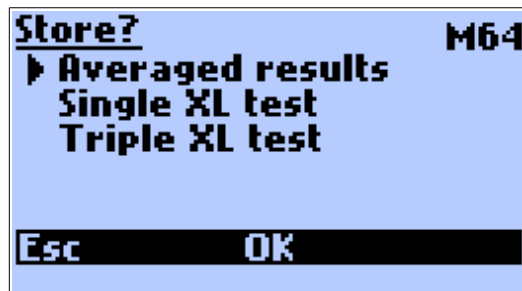

The averaged results will be stored. The averaging times that can be chosen from 2, 10, 20, 30, 60, 120 and 180 seconds.

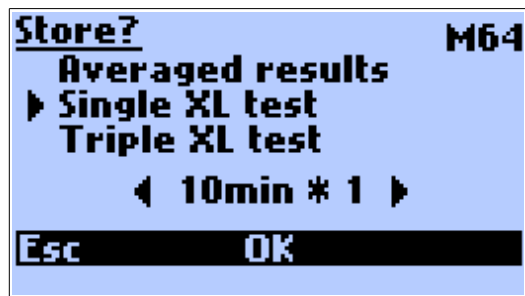
Single XL test:

The averaged results will be stored. The term XL (extra long) is used for the formation of especially long averages. XL test time can be set via [Options](#) second screen or on current screen by the use of the keys: ◀ and ▶

Available times: 10sec, 20sec, 30sec, 1min, 2min, 5min, 10min, 15min, 20min, 30min.

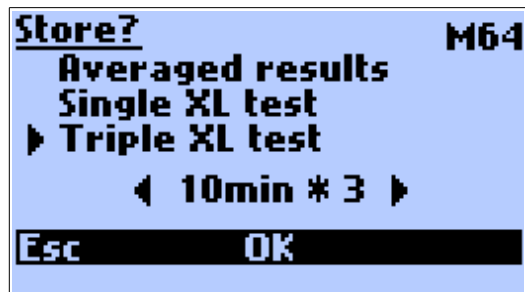
Triple XL test:

This will automatically store three consecutive single XL Tests.

During storage of XL test, battery charge icon is replaced with the number of current test (X1, X2, X3) and the clock counts down the time, till the end of test. During the XL test the analyser beeps every two seconds.

In the top-right corner the number of available reports is shown:

Available reports number

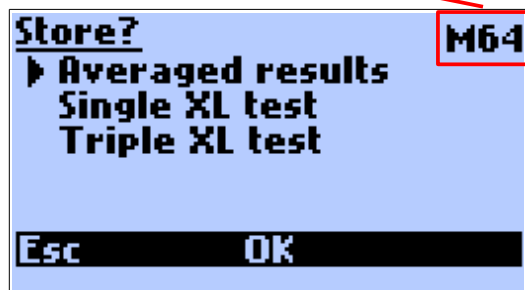

If the memory of analyser is full, and no more reports can be stored the following screen is shown when the storage is attempted.

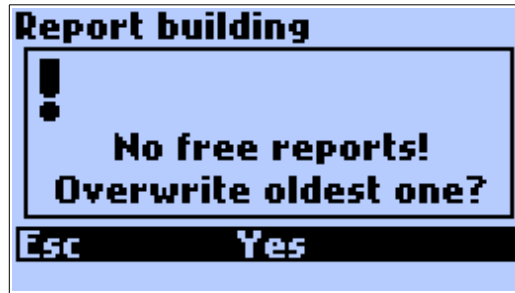

ECS

The storing of results will be stopped and the instrument returns automatically to the results screen.

YES

The oldest report(s) will be deleted and the new one(s) stored instead.

If the results are to be stored, then the instrument will request a customer number (identification number of the report). This number will appear on the report.

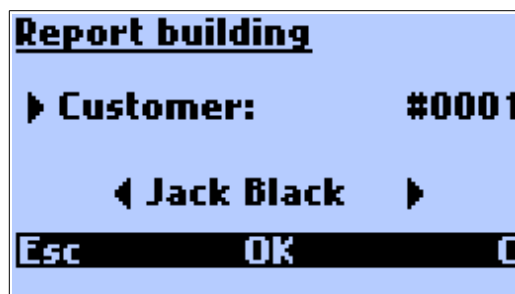



When the number has been entered and confirmed with **OK**, the following screen will appear momentarily.



This completes the storing of the results and the instrument will return automatically to the results screen. The number that appears on the confirmation screen **#00064** is the serial number of the report registered by the analyser. The reports counter can be restarted by the use of the madurPortable PC software.

There is a possibility of stopping and shortening the XL test.

If the function key  is pressed during the single XL test or during the X1 test (the first test of tripple XL test) then the measurement is stopped and result is not stored. If the

function key  is pressed during the X2 or X3 test, the measurement is disrupted but it's result will be stored.

During the XL test, its result can be viewed. Pressing the  key during displaying the results screen, for a few seconds, the XL test results' will be shown (averaged for the period of time since the beginning of the test).

4.2. Action menu

Pressing the centre function key on the results screen will open **Action** screen.

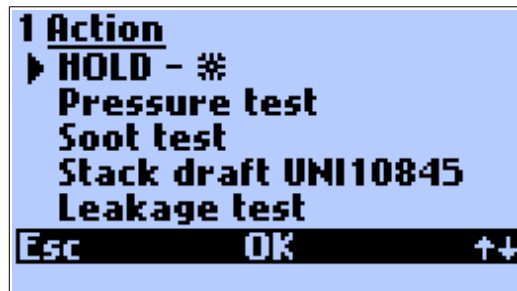

Pressing the right function key  will switch to the second page:

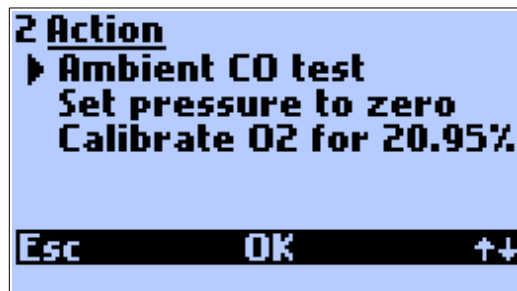

Hold

The present measurement values are frozen and the screen will spring automatically to the frozen values. Pressing the centre function key again will end the freezing of the values. Hold mode is signalled by flashing  sign over the central function key.

Note:

Holding the measurement can hold the pump. Settings are made by the use of the option „*Pump stop when hold*” from madurPortable PC program. If this option is ticked every time the test is held the pump is turned off until it's restarted.

Pressure test

The following screen will appear:

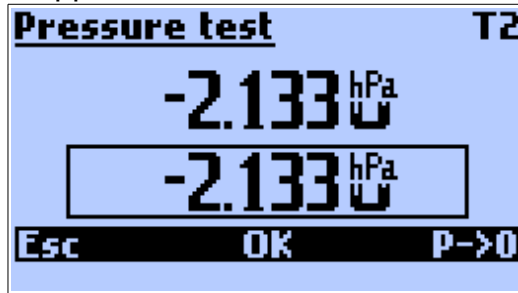

The upper displayed value is the currently measured pressure value. The value in the frame is the value stored for a printout or a report.

T2 in the right upper corner is the set averaging time. If the period of the time since the beginning of the measurement is shorter than the chosen averaging time, the current averaging time of the test will be displayed.

P->0 key is used for the zeroing of the sensor. It is important that during this process there is no pressure applied to the sensor.

OK key stores the measured pressure value (it will appear in the frame at the bottom of the display).

The value is stored until the next print of the results is done or the next report is stored, later it is erased.

The pressure test is carried out differently for the instruments equipped with optional pressure sensor and the instruments without one.

The analyser without the optional pressure sensor.

Only the single-inlet pressure measurement is available. This is carried out via the inlet situated at the bottom of the instrument's case. During the pressure test the pump must be switched off (it is automatically switched off when the screen shown above appears on the display). The pressure test can be carried out only when the **Pressure test** screen is displayed. The flow velocity test carried out with the use of Pitot tube is not available.

The analyser with the optional differential pressure sensor

If the analyser is equipped with the optional differential pressure measurement sensor (the inlets at the top of the analyser's case) the differential pressure measurement is available. The pressure measurement is carried out simultaneously to all the other measurements. It is not necessary to hold the pump and the flow velocity test can be carried out with the use of Pitot tube.

Soot test

The soot test can be carried out provided that the analyser is being supplied with energy from outside. The efficiency of the pump powered by the inner battery is not enough to carry out the test. Also the heating of the probe holder (necessary when carrying out the soot test) requires that the instrument be powered by the mains adapter. If the instrument is not powered by the mains adapter the following screen will appear:



The user should plug the mains adapter to the instrument. After choosing the option **Soot test** the user will be asked to put the filter in.

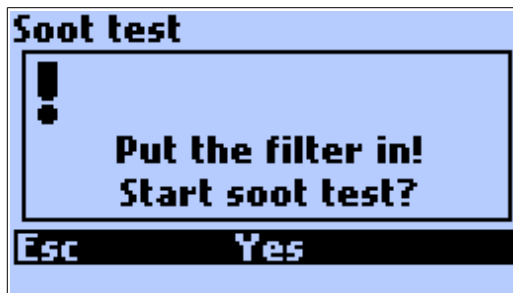

After confirmation the measurement will begin.

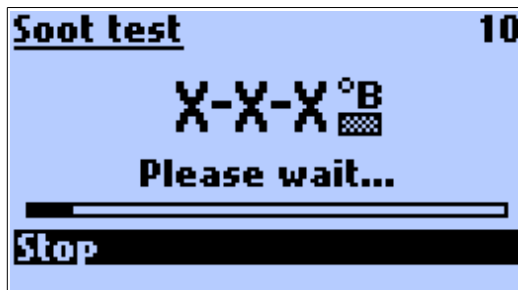

The measurement can be disrupted with function **Stop**.

Once the measurement is finished the following screen will appear.



With the use of arrow keys the value taken from the comparative scale should be filled in and confirmed with **OK** key. It is possible to save three measurements results ($_1X$, $_2X$, $_3X$) which will be visible in a saved report.

Leakage test

This option is used to check the pressure tightness of the measured circuit. Analysers makes two test using pressure sensor and compares them.

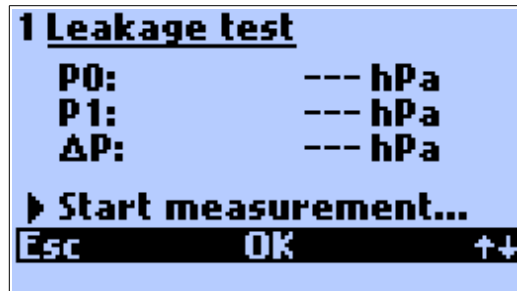

Pressing the right function key  will switch to the second page:

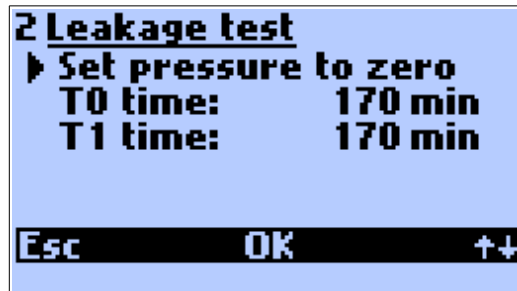

P0 – first pressure test result

P1 – second pressure test result

ΔP – difference between P0 and P1 results

Set pressure to zero – zeroes the pressure sensor

T0 time – time of the first pressure test (1min. to 15 min.)

T1 time – time of the second pressure test (1min. to 15 min.)

Pressing the middle function key  on the first screen starts the test

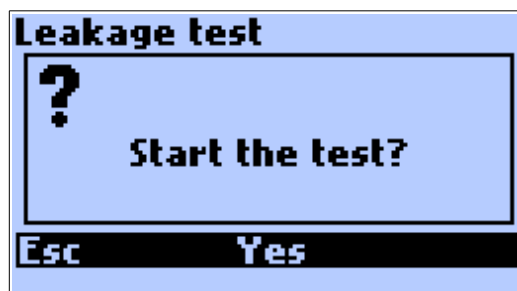

After confirmation the first test starts followed by the second one.

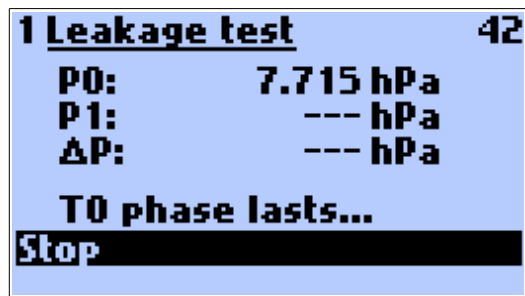

After the first and the second test summary will provide information about the pressure tightness.

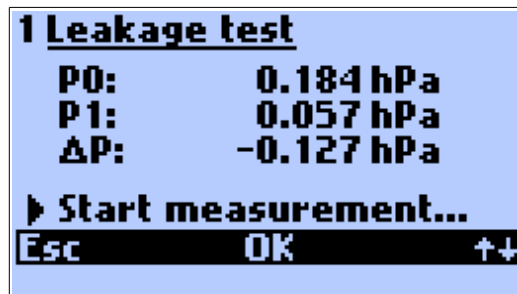

Ambient CO test

This option is used to measure the ambient CO level. After this option is chosen the user will be asked if he want to start the test.

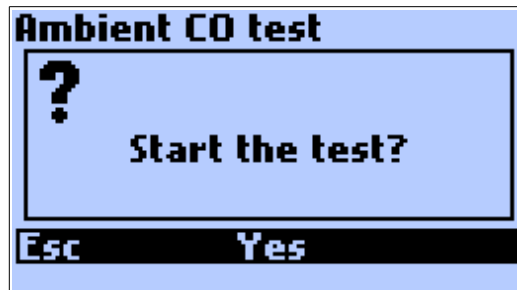

After confirmation the measurement will begin.

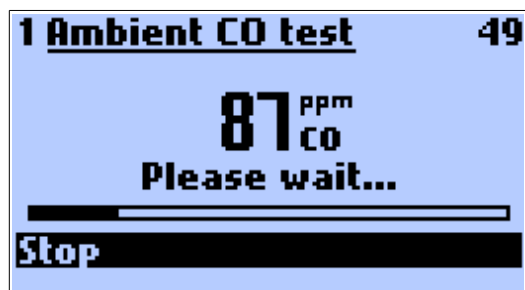

The measured value of ambient CO will be stored and will appear in the next report.

Set pressure to zero

This option is used to zero the pressure sensor.

Calibrate O2 for 20.95%

In order to increase the accuracy of long-period measurements GA-12 *plus* has the possibility of calibrating the O₂ sensor on demand. Before choosing the command *Calibrate O2 for 20.95 %* the probe should be removed from the stack and the readings should be stabled. Calibration of the O₂ sensor can be followed by the zeroing of all the other gas sensors. Suitable settings can be done via madurPortable PC program.

4.3. Chart

The instrument can display the measurement results for the last 190 seconds. The most recent value is on the right-hand side of the chart. The arrow left/right keys are used to scroll the marker enabling one to read the exact value at each point of the chart.

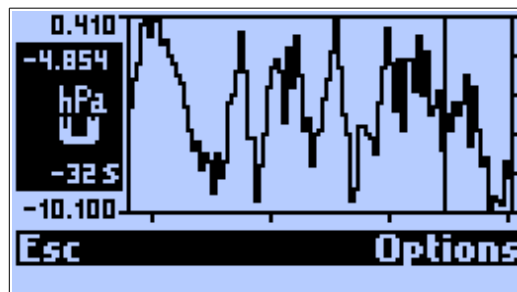

the values on the left have the following meanings:

- Maximum value of the Y axis (here 0.410).
- Current value or, when the marker is activated, the marker value (here -4.854).
- The unit (here hPa). This appears automatically with the variable.
- The variable (here pressure). The arrow up/down keys can be used to scroll through the variables.
- Marker time (here -32s). This means the marker stands on the value that was recorded 32 seconds earlier.
- Minimum value of the Y axis (here -1.100)

The menu bar

ESC

Leaves the *Chart* and returns to the results screen.

Options

This opens the window for the *Chart settings*. The following screen appears:

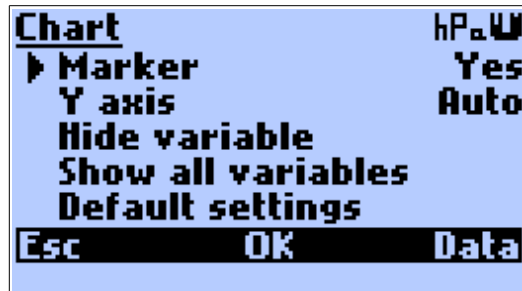

Description of the options:

Marker

Switches the marker on or off.

Y Axis

The scale system for the Y-axis can be set. These are the options:

- Auto (automatic scale) – the instrument chooses according to the measured values.
- Manual – can be set by the user with the madurPortable PC program.
- Full – done according to the measurement range of the variable

Hide variable

After confirmation with *OK* the variable will no longer be shown on the chart. Can be re-activated using *Show all variables* or with the madurPortable program.

Show all variables

After confirmation with *OK* the instrument will show all measured and calculated variables on the chart.

Default settings

After confirmation with *OK* the instrument will show some important measured and calculated results: O₂, CO, ETA, Lambda, Tgas.

4.4. Measurement parameters

The right function key will access **Options** from the results screens.

The following screen appears:

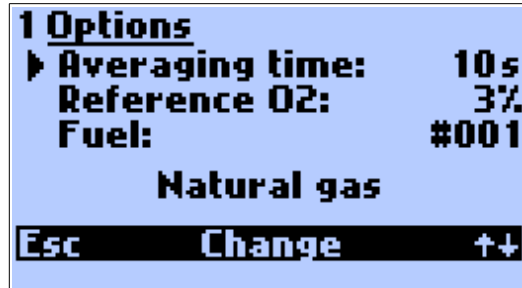

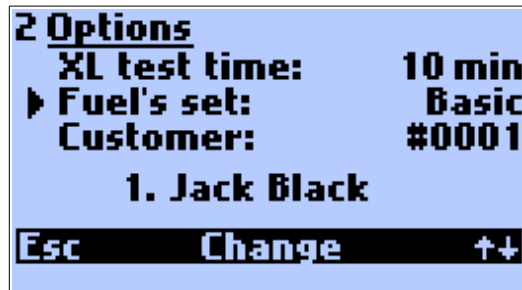

Pressing the right function key  will switch to the second page:



Averaging time



The averaging times ranging from 2 to 180 seconds can be set using the arrow left/right key.

Reference O2

By using arrow   keys or the function key *Change* reference O2 value can be changed in the range 0-13% O₂.

Note: If option „Use O_{2ref} from fuel data” was ticked in service program madur-Portable then there is no possibility to change the reference oxygen in the instrument, this value is adopted from defined fuel parameters.

Fuel

The following 6 fuels can be set using the function key **Change** or the arrow  .

Basic fuels

- 0- Light oil
- 1- Natural gas
- 2- Town gas
- 3- Coke-oven gas
- 4- Liquid gas
- 5- Extra light oil

There are also 4 memory locations (6-9) for 4 fuels specific to the user which can be freely programmed by the user. This is carried out using the madurPortable PC program.

There is a possibility to replace the first standard fuels with the set of ÖNORM or Italian fuels. This can be chosen on the second page of option menu in Fuel's set line.

The Austrian fuels:

- 1- Erdgas
- 2- Flüssiggas
- 3- Heizöl HEL
- 4- Heizöl EL
- 5- Holz
- 6- Kohle

The Italian fuel set

- 1- Gas naturale
- 2- GPL
- 3- Gasolio
- 4- Olii combustibili
- 5- Pellets

XL test

Using the key *Change* or arrow left/right key allows setting the XL test time. The following values are available:

10sec - 20sec - 30sec - 1min - 2min - 5min - 10min - 15min - 20min – 30min

Customer

By using arrow ◀▶ keys or the function key *Change* customer data can be changed. Customers can be defined in madurPortable PC program.

4.5. Main menu

From the results screen the **Menu** option is available after the use of the key: ▷.

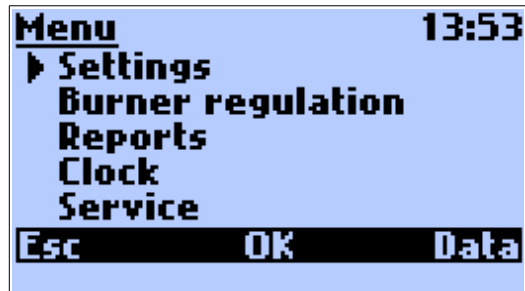

4.5.1. Settings

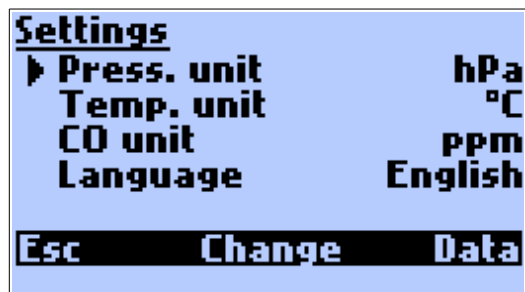

The *Settings* Menu can be used to change following parameters:

Pressure unit

There are four pressure units available: hPa, Pa, mmH₂O and inH₂O.

Temperature unit

Two units are available: °C and °F.

CO unit

There are two units available: % and ppm. % is available only if the sensor with a widened CO range (10%) has been installed.

Language

The instrument is pre-programmed with a number of languages. There is also a possibility of downloading an additional language through madurPortable program. In case of an accidental language change (when having problems with finding the proper setting in the analyser's menu) it is possible to restore the default language by keeping the key ◁ pressed when starting the analyser. The choice of the default language is made in madur-Portable program.

4.5.2. Burner regulation

This option allows the combustion process in a burner to be visualised. Three variables that define the combustion process are shown graphically.

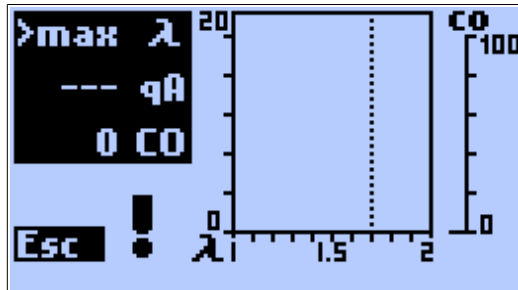

These are:

CO – carbon monoxide concentration

qA – stack loss

Lambda – Excess air

All three appear on the screen at the same time. This means that the dynamic connection between all the variables is easily seen and the air inlet can be adjusted for optimal combustion.

- qA is shown as a diagonal straight line that will move up or down when adjustments are made. This is shown in the range 0...20 %.
- Lambda is a vertical straight line, which will move left/right during adjustment. This is shown in the range 1...2.

The user can also set two markers to define the desired range for Lambda. If the Lambda becomes larger than the value defined by the right marker, an arrow on the left-hand side points downwards meaning that the air flow must be reduced. If the value becomes smaller than the value defined by the left marker the arrow points upwards meaning that the air flow should be increased.

On the right-hand side of the display the CO concentration indicator is shown (used range: 0 – 100ppm)

4.5.3. Reports

This option is used to administrate the stored reports.

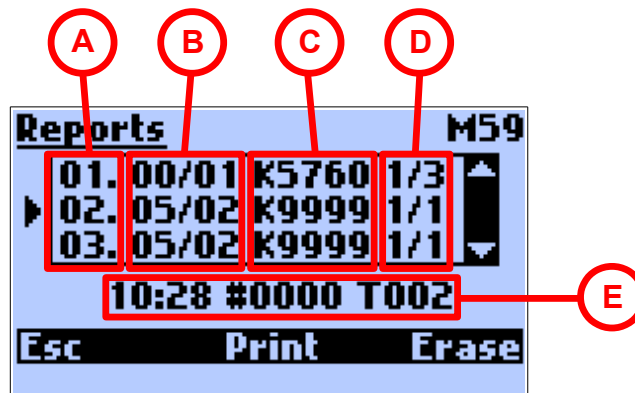

The fields have the following meanings:

- The report number given to the report within the reports table (1..64).
- The creation date of the report. Displayed in the format defined in the menu **Clock**.
- The customer's number.
- These numbers inform the user of whether the report is a single one; or the first/second or the third of the three reports of a triple XL test – 1/3, 2/3, 3/3
- In this field the additional information on the marked report will be displayed. This includes the exact creation time of the report – 10:28, the serial number of the report registered by the analyser #0000 and the averaging time – in this case two seconds.

In the right-hand upper corner the information on how many memory spaces are still available is displayed.

Esc returns to the **Menu**. To erase the report use the **Erase** button; the confirmation screen will be displayed.

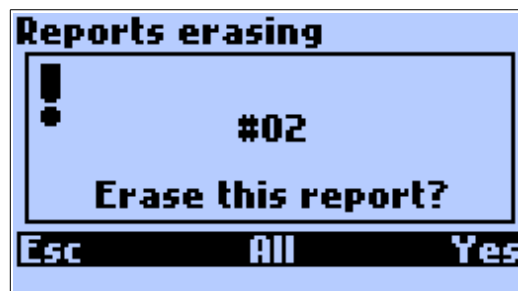

Pressing **Esc** returns to previous menu. Pressing **Yes** will erase the chosen report, pressing **All** will delete all stored reports.

After pressing the **Print** key the following screen will appear:

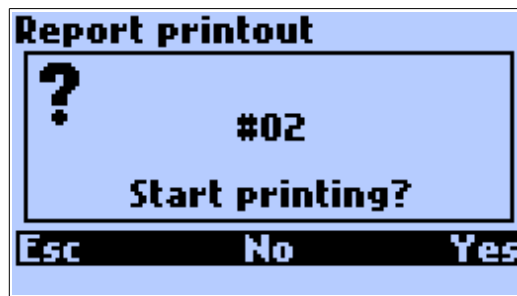

Using **Esc** or **No** returns to the previous screen, choosing **Yes** starts printing. If the chosen report is a one from the triple XL test report, the following screen is displayed:



Choosing **Triple** causes averaging and printing all three parts of triple report as a whole.

Attention!

Check if the printer is on and it's receiver is near the upper edge of the analyser.

It is also possible to define printing format. This can be done only in the window *Print* see point [Print](#).

4.5.4. Clock

In the *Clock* Menu options the following settings (as shown in the picture) can be changed:

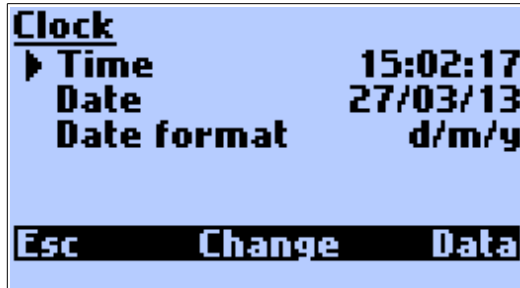

Time

The time displayed by the inner clock can be set.

Date

The date indicated by the inner calendar can be set.

Date format

Two date representation formats are available. The user can choose between: Day – Month – Year and Month – Day – Year date format

4.5.5. Service

The following screen appears when the option is opened:

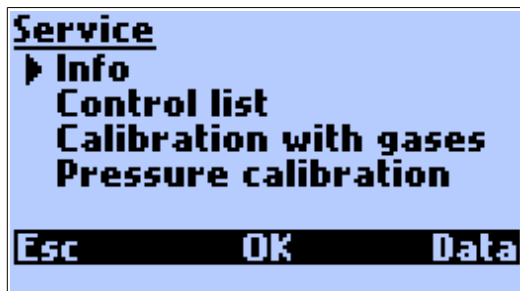

4.5.5.1. Info

On the **Info** screen the information concerning the configuration of the instrument are displayed.

| 1 GA12plus info | |
|-----------------|----------|
| Software: | 5.9.0 |
| Serial No: | 14430112 |
| Last report: | #00003 |
| Fast printer: | Yes |
| Pdif sensor: | --- |
| Esc | ↑↑ Data |

Using the ↑↓ key will evoke the next **Info** screen.

| 2 GA12plus info | |
|-----------------|---------|
| Sensor O2: | O2-A2 |
| Sensor CO: | CO-AF |
| Sensor #3: | NO-AE |
| Sensor #4: | SO2-AE |
| CO range: | 4kppm |
| Esc | ↑↑ Data |

4.5.5.2. Control list

The option **Control list** shows all measured signals. This is of great use when searching for possible defects. The content of the **Control list** is displayed on the three screens numbered 1, 2 and 3.

| 1 Control list | | | |
|----------------|-------|-----|-------|
| Ta | --- | 0.0 | 32753 |
| Ti | --- | 0.0 | -2 |
| Tg | --- | --- | 32744 |
| Tc | --- | 0.0 | 32752 |
| O2 | 20.95 | | 13477 |
| Esc | | ↑↑ | Data |

| 2 Control list | | | |
|----------------|--------|----|------|
| CO | 0 | -4 | 366 |
| NO | 0 | -3 | 0 |
| #4 | 0 | -4 | -1 |
| P1 | >max | | --- |
| P2 | -0.015 | | -26 |
| Esc | | ↑↑ | Data |

```

3 Control list
Ub 0.027  →  139
SH ---      0
ST ---      0
EEPROM:      Small
Calibration  OK
Esc  ↑↑  Data

```

The ↑↓ key is used to change between the consecutive screens of the **Control List**.

4.5.5.3. Calibration with gases

Calibration with gases is about observing the sensors' reaction to the familiar to the user gas concentration. The access to the calibration is originally blocked at the factory. If so after choosing the option the following screen will appear:

```

!
Option disabled...

```

Unlocking the calibration process is possible via the madurPortable PC program.

Warning:

Each incorrect change of the calibration value will cause an irreversible loss of the previous values thereby the instrument will become of no use for the further measurement. The calibration should be therefore carried out only by the qualified staff of the service.

Choosing the option *Calibration with gases* displays the following screen:

```

CALIBRATION WARNING!
!
ARE YOU SURE?
Esc  Yes

```

After confirmation the following screen will appear:

```

Calibration with gases
▶ Calibration  CO
  Calibration  NO
  Calibration  SO2
Esc  OK  Data

```

The screen makes it possible to choose between the calibration gases.

The process of calibrating will be presented for CO.

| Calibration | | | CO |
|-----------------|--------|------|-----|
| | PPM | M | S |
| CO | 0 | 1421 | -4 |
| #3 | 0 | -6 | -4 |
| #4 | 0 | 248 | -5 |
| ▶ Concentration | | | 401 |
| Esc | Change | | OK |

The Change key evokes the screen used for entering the reference gas concentration value.

| Calibration | |
|---|--|
| Enter concentration | |
|  | <div style="border: 1px solid black; padding: 5px; display: inline-block;"> 0401 PPM CO </div> |
| ▲ | |
| Esc | OK C |

After applying the gas to the instrument it is advised to wait until stable values appear in the S (signal) column and then to press the OK key. The values from the S column will be saved and stored in the column M (memorised).

4.5.5.4. Pressure calibration

Pressure calibration like gas calibration is available only to the service staff. To carry out the calibration process it is necessary to have a precise pressure source.

Warning:

Each incorrect change of the calibration value will cause an irreversible loss of the previous values thereby the instrument will become of no use for the further pressure measurement. The calibration should be therefore carried out only by the qualified staff of the service.

After choosing the pressure calibration option the following screen will appear:



After confirmation the following screen will be displayed.

| Pressure calibration | | |
|----------------------|--------|--------|
| | Signal | Pa |
| Measured | 58 | 4.6 |
| Stored | 17907 | 1513.0 |
| ► Pressure | | 1513 |
| Esc | Change | OK |

The fields on the screen have the following meaning:

Measured

The signal currently supplied by the pressure sensor and the pressure measured by the instrument.

Stored

The previously stored signal and calibration pressure.

Pressure

Calibration pressure in [Pa].

The calibration process

Apply the calibration pressure to the instrument. With the *Change* key fill in the value of the calibration pressure. Press *OK* to store the value of the calibration pressure.

4.6. Printing

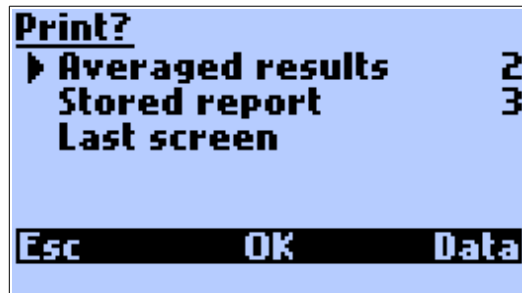

Using the arrow left/right keys for given line will cause the change of the printing format. There are four default, set at the factory formats, the other four can be defined by the user with the help of the PCGA12plus.exe program.

Averaged results

The last measured temporary values will be printed.

Stored report

Report printout. After choosing this command the window of administrating the reports will be displayed.

Last screen

The content of the last screen displayed will be printed.

5. FLOW VELOCITY MEASUREMENT

The GA12 analyser is able to measure the differential pressure of the flue gases and can be equipped with a Pitot tube with which the flow velocity measurement can be performed. This value is necessary when calculating the mass flow velocity and the mass of pollutants emitted by the source in a particular period of time. The system calculates the

$$v \left[\frac{m}{s} \right] = 1.291 * \sqrt{\frac{T_{gas} [K]}{289} * \frac{100000 Pa}{100000 Pa + P_{stat} [Pa]} * P_{dif} [Pa]}$$

values using the formula:

v – flue gas velocity [m/s]

1.291 – coefficient of the Pitot tube

T_{gas} – flue gas temperature [K]

P_{stat} – static pressure [Pa]

P_{dif} – differential pressure [Pa]

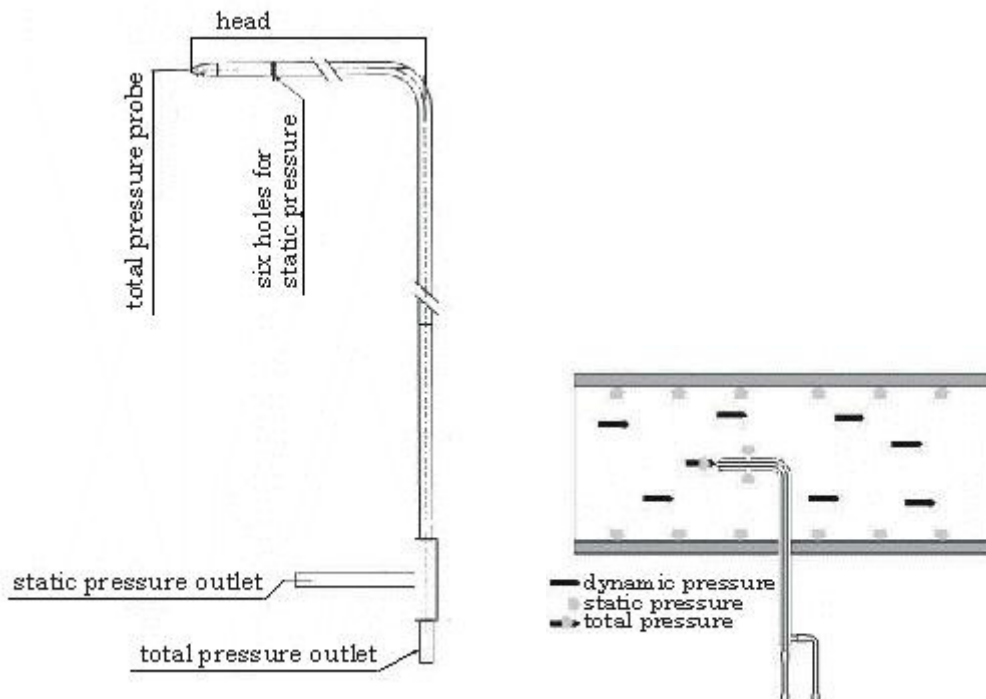

The Pitot tube consists of two concentric tubes with one end bent at a right angle. The total pressure inlet is situated at the very end of the tube. The flue gases flow parallel to the bent end of the tube. The holes used for measuring the static pressure value are situated at the circumference of the transverse section of the bent end of the tube (see the picture above) which means they are perpendicular to the direction of the flue gas flow. The static pressure measurement can be performed as the flue gas flow causes a negative pressure to occur in the static pressure holes.

The tube must be connected to the analyser inlets (the total pressure outlet of the tube – to the analyser's differential pressure sensor inlet (+) and the static pressure outlet of the tube to the analyser's differential pressure sensor inlet (-)).

The GA12 analyser measures the difference between the values of the total and the static pressure (which means the differential pressure) and calculates the flue gas velocity on the basis of these measured values. The calculated value can be displayed on the results screen.

The results of the measurement performed with the use of a Pitot tube are correct provided that the analyser position is not changed after the beginning of the sensor zeroing process and both the device and the tube are held in the same (described above) position throughout the measurement process.

This measurement will only provide the flow velocity at a single point in the cross section of the flue gas channel, but at normal flue gas flow rates the velocity profile will be reasonably constant across the cross section. With use of the cross sectional area of the flue gas channel, the volume and hence mass flow rates can be calculated.